

SUMITOMO

SUMITOMO

SH330-6
 SH330LC-6
 SH350HD-6
 SH350LHD-6

- Engine Rated Power (Net): 198 kW-269 PS
- Operating Weight:
 - SH330-6 34,100~34,900 kg
 - SH330LC-6 34,700~35,600 kg
 - SH350HD-6 36,200~36,900 kg
 - SH350LHD-6 36,700~37,500 kg
- Bucket Capacity (ISO Heaped): 1.4~1.8 m³



 **SUMITOMO (S.H.I.)
 CONSTRUCTION MACHINERY CO., LTD.**

731-1 Naganumahara-cho, Inage-ku, Chiba, 263-0001 Japan
 For further information please contact: Phone : +81-43-420-1829 Facsimile : +81-43-420-1907

We are constantly improving our products and therefore reserve the right to change designs and specifications without notice.
 Illustrations may include optional equipment and accessories and may not include all standard equipment.

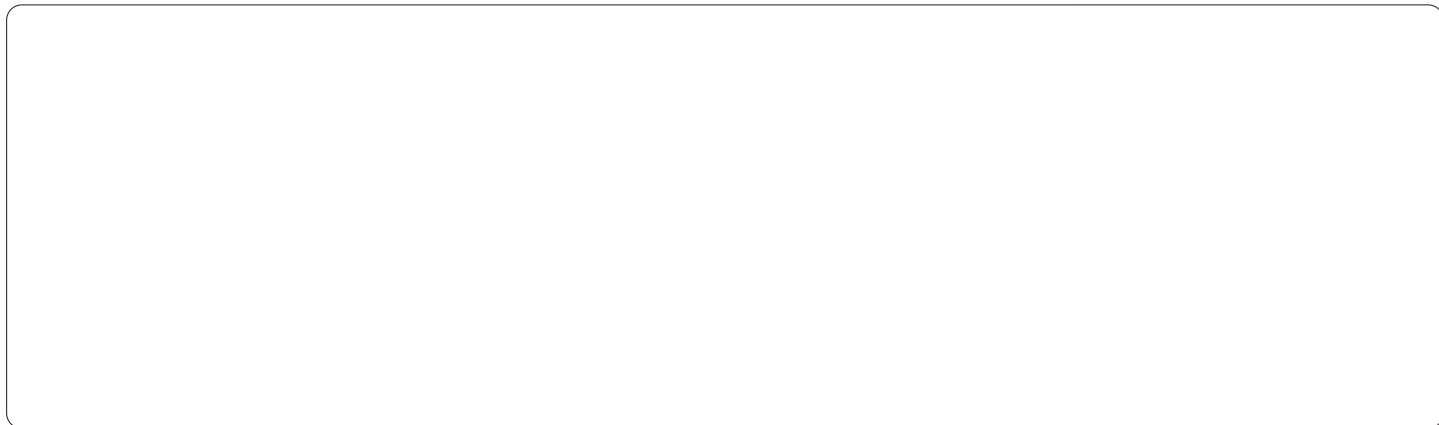

Performance Refined. Evolution Defined.



ENGINEERED IN JAPAN

The world knows that Japanese designed and engineered products represent the highest quality, especially for Industrial Products. The hydraulic excavator is no exception when a totally integrated concept is required in design work involving key components, manufacturing engineering, and product quality assurance in the factory. SUMITOMO hydraulic excavators are designed and manufactured today to meet the global demands of our many customers with the concept of Performance, Reliability, and Fuel Efficiency foremost in our minds. This proven Japanese technology and quality gives SUMITOMO excavator customers total peace of mind and provide a complete solution for the demands of the construction industry.

Engine and Hydraulics 04-07

- New Generation Engine System "SPACE 5+"
- New Hydraulic System "SIH:S+"
- SUMITOMO Fuel Efficiency Technology
- Increased Productivity Drastically

Durability and Maintenance 08-11

- High Rigidity Attachments
- EMS
- Ground Level Maintenance

Safety and Operator Comfort 12-17

- Stylish and Spacious Cabin
- High-Definition Full Colour LCD Monitor

Specifications 18-27



**Performance Refined.
Evolution Defined.**



New Engine System **SPACE 5+ PLUS** + New Hydraulic System **SIHIS PLUS** = **5% Reduction in Fuel Consumption**
(as compared with SH350HD-5 [H mode])

New Generation Engine System "SPACE 5+"

The new engine system optimises fuel efficiency and environmental performance via the advanced common rail fuel injection system, cooled EGR system, and turbocharger with W/G (Waste Gate). At the same time, excellent response times are achieved.

Engine and Hydraulics



SH350HD-6 has achieved a 5% fuel saving in comparison with our DASH 5 series, by fusing the new generation engine system "SPACE 5+" and the new hydraulic system "SIH:S+", further refining fuel efficiency. At the same time the newly developed ISUZU engine, contributes greatly to the environment.

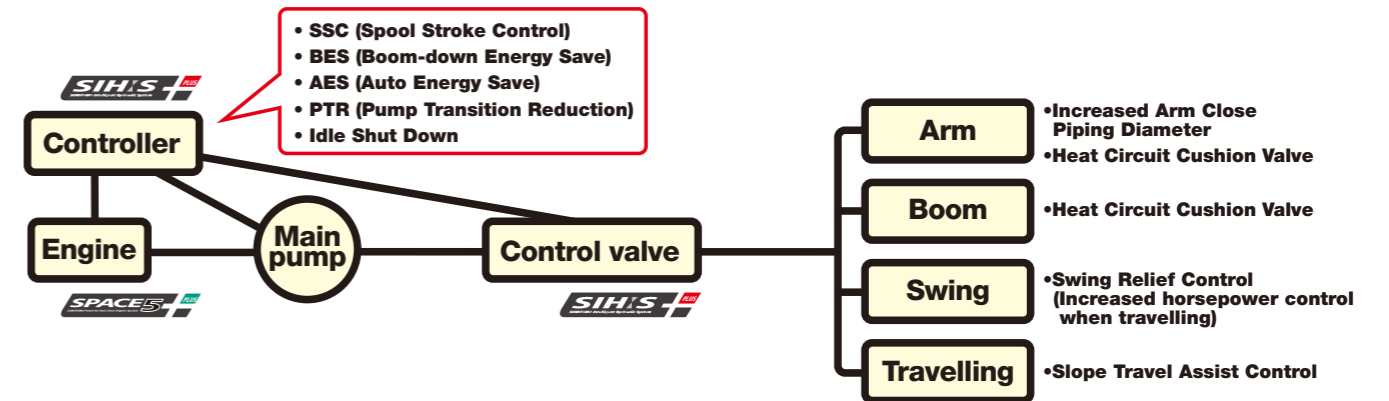

Mode Selection by Throttle **SUMITOMO UNIQUE DESIGN**

There are three working modes available: SP (Super Power) for heavy duty applications, H (Heavy) for normal working conditions, A (Auto) for a wide range of operations.



Further Improvement of Fuel Consumption

The new technology has improved operations and reduced fuel consumption on each working mode.

- H mode **5% Reduction in Fuel Consumption**
- A mode **10% Reduction in Fuel Consumption**
(as compared with SH350HD-5)

*Fuel consumption may vary from time to time depending on site and working conditions, operator skill and other circumstances.

ECO Gauge Showing Low Energy Operation

The energy saving conditions can be seen at a glance, as well as the fuel consumption indicator shown on the monitor.



SUMITOMO Technology for Fuel Efficiency

- SSC (Spool Stroke Control) **SUMITOMO UNIQUE DESIGN**
Reduces engine load upon heavy duty operation.
- BES (Boom-down Energy Save) **SUMITOMO UNIQUE DESIGN**
Lowers engine speed upon boom-down and swing operation which does not require large oil flow.
- AES (Auto Energy Save) **SUMITOMO UNIQUE DESIGN**
Lowers engine speed accordingly when low engine load is sensed.
- PTR (Pump Transition Reduction)
Decreases engine load when the pump flow requirement is reduced upon abrupt pump load.
- Idle Shut Down & Auto Idle

Upon activation, idle shut down automatically shuts the engine down when the machine is not in operation for set amount of time. Auto Idle is also available, which makes the engine begin idling approximately five seconds after the operation levers are in neutral position.





**Performance Refined.
Evolution Defined.**

Engine and Hydraulics



SUMITOMO's original technology Spool Stroke Control (SSC), perfectly matches the engine and hydraulic power, and further improves the operational speed whilst maintaining smooth control of the machine.

Work Efficiency Drastically Increased SUMITOMO UNIQUE DESIGN

Spool Stroke Control (SSC) variably controls spool port flow rate, depending on the condition of operation. Improved power, speed, and smoother controls mean that work efficiency is dramatically increased.

10% Faster Cycle Time (SP mode)

Speed increase by 10% in cycle time has been achieved, giving further advance in productivity (as compared with SH350HD-5 [SP mode]).

Real Digging Power

The true digging force can not be expressed by a maximum digging power figure listed in sales brochures. With an improved hydraulic system and with a large arm cylinder, the arm-in motion speed slowdown is minimised. The digging power when combined with the attachment speed in motion convert to the operator's "Real Digging Power".

Automatic Power Boost

The digging power increases automatically in quick response to the working conditions during heavy-duty digging work. This is a design unique to SUMITOMO, and continues for eight seconds (SP/H mode).

Speed and Power, Increases Productivity Drastically

• SP mode **10% faster cycle time**
 • H mode **7% faster cycle time**
 • A mode **7% faster cycle time**
(as compared with SH350HD-5)

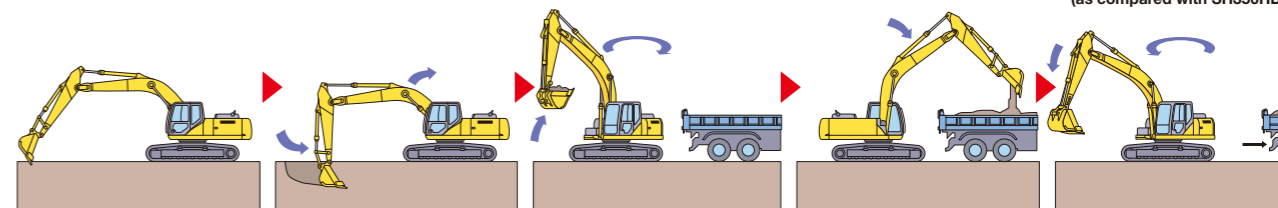

*Based on SUMITOMO's testing condition and results.

Operating Condition Easily Viewable on Display

Various control such as working modes and auxiliary hydraulic setting can be easily selected by the universally designed switch panel, and what's being selected can be easily viewed on the 7" wide monitor.





Durability

Heavy duty applications for SH350HD(LHD)-6

EMS (Easy Maintenance System) as Standard

SUMITOMO's EMS keeps the pins and bushes fully lubricated at all times and prevents rattling. This system significantly extends the service life of the pins and bushes.

The lubrication interval is 1,000 hours, keeping the joints lubricated for a long time and extending the service life of parts by reducing abrasion and rattling.



• Greasing interval: 1,000 hours

* The greasing interval depends on the working conditions.

Precautionary use of EMS

- ① Grease is enclosed, however greasing is necessary every 1000 hours or six months depending on the level of dusting conditions.
- ② Greasing is also necessary after any components have been submerged underwater for prolonged periods.
- ③ Greasing is also recommended after use with hydraulic breakers, crushers or other high impact attachments such as Rock Saws etc.
- ④ Bucket pins should be cleaned thoroughly when removing or attaching new buckets.

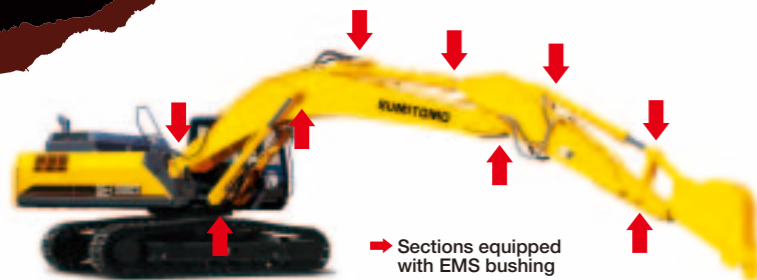

High Rigidity Attachments

The structure of boom and arm has been further improved, ensuring strength and durability. In addition, high strength castings are used for boom base and arm end, improving durability.

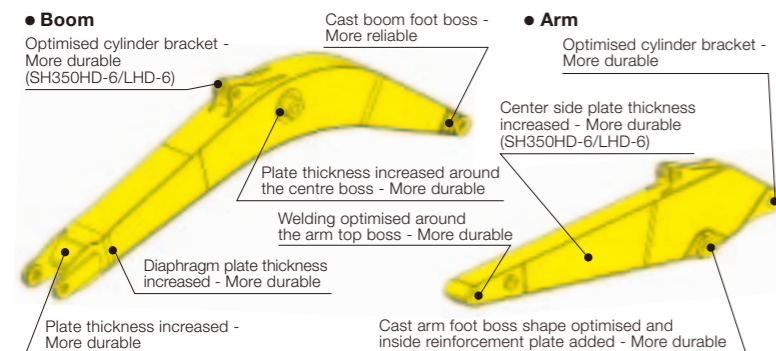

High Rigidity Undercarriage

For improved mobility, the track system has been strengthened ensuring longer wear life, performance, and improved durability.

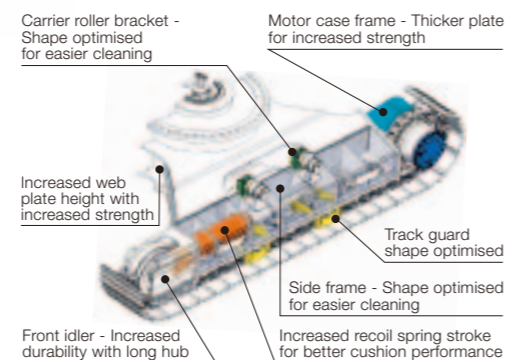

- Heavy duty arm
■ Heavy duty boom
- Dipper edge ribs arm reinforced
- Heavier counterweight
- High durability bucket
The design of a high wear-resistant "Super-V" increases durability.
- Strengthened side frame
- Side bumper guards (heavy duty)



**Performance Refined.
Evolution Defined.**

Maintenance

Serviceability and durability are also important points of machine performance. Ground level access to the engine area makes daily maintenance extremely straightforward. Reliability has been further enhanced by increasing cooling capability and durability.

Ground Level Access to Engine Area Improves Preventative Maintenance

Parts cleaning and maintenance are possible from the ground without climbing onto the upper structure of the excavator body.

• Increased Cooling Capability

With the larger radiator and oil cooler, cooling capacity is increased, thus improving reliability. In addition, cleaning of the dust-proof net is simplified.

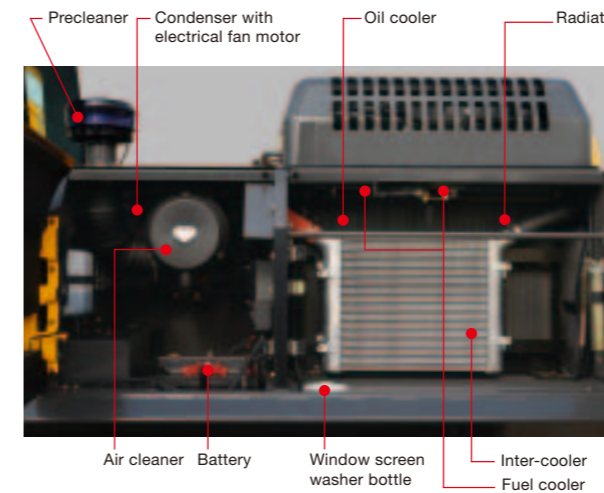

• Easy Filter Replacement

A fuel prefilter with water separator and water level sensor are provided as standard equipment to reduce maintenance trouble. In addition, the fuel and oil filters are installed at ground-accessible location to facilitate replacement.

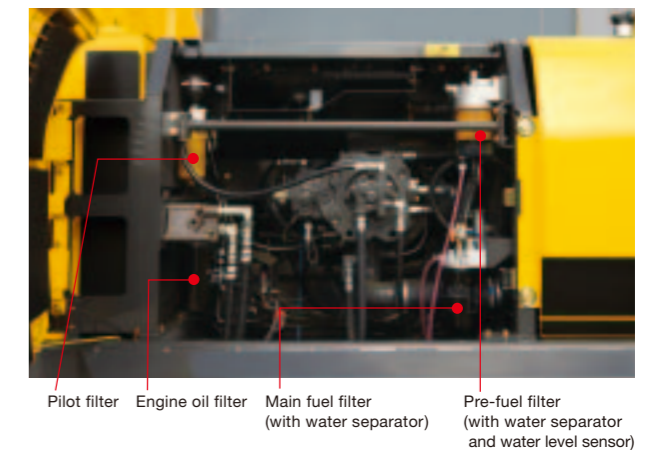

High-Performance Return Filter

The hydraulic oil change interval is 5,000 hours, and the return filter change interval is 2,000 hours. One high performance return filter keeps the same level of filtering as a nephron.



• Hydraulic oil change: **5,000** hours

• Life of filter: **2,000** hours

* The oil and filter change interval varies by the working conditions.

Pre-air Cleaner

An automatic exhaust type pre air cleaner is provided as standard. The air cleaner cleaning frequency is minimised, even when operating in dusty conditions.



Easy Access to A/C Filter

The air intake filter is located in a lockable compartment to make it easier to replace, and access to the inside cab filter has been simplified.



Cab Floor Mat **SUMITOMO** UNIQUE DESIGN

The washable floor mat has been redesigned for ease of removing and cleaning.



Fuse Box Location

The fuse box has been located in a separate compartment behind the seat, allowing easier access.



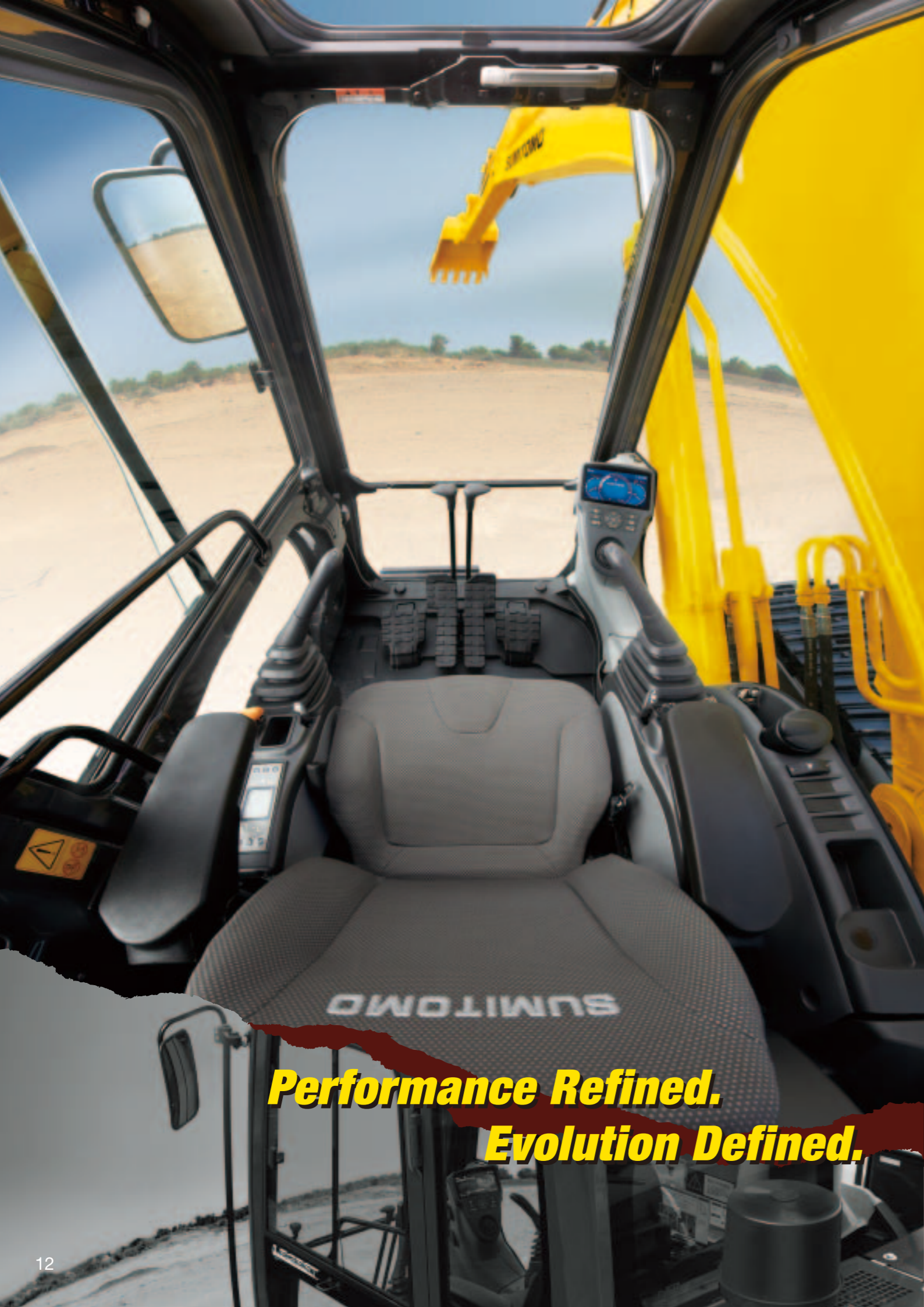

**Performance Refined.
Evolution Defined.**

Safety and Operator Comfort

Planning for safety in the event of a roll accident, a new strengthened safety cabin has been provided. The reinforced cabin greatly increases operator's safety.

Newly Designed Strengthened Safety Cabin

The optimised design and strengthened parts increase the overall cabin strength. Even if the shovel were to tip over, the safety of the operator is ensured by keeping cabin deformation to a minimum.

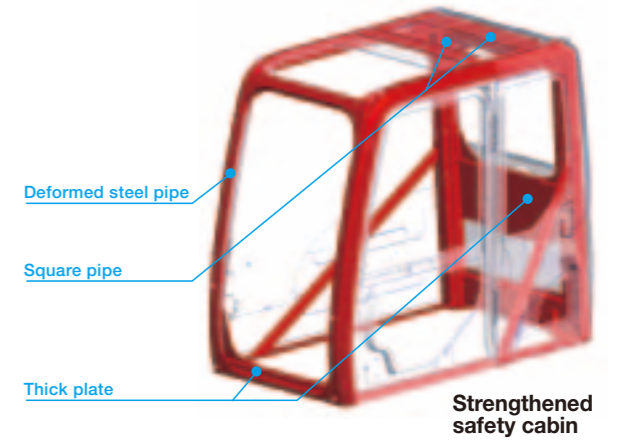

Wide View Increases Safety of Work

In addition to the wide front view, the upper view has been widened to enhance work safety.

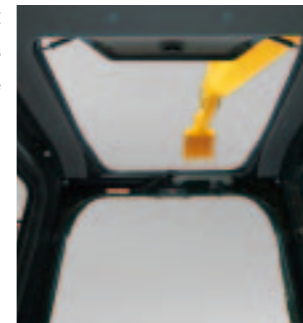

Safe and Easy Entry into and Exit from the Cab

A large handrail for easy opening/closing of the door and increased floor space permit the operator to get in and out of the cab easily.



New Cab Suspension Mounts

The new cab suspension mounts reduce vibration and impact transmitted to the cabin, and improve the operator's sitting quality and reduce operator fatigue. The sealed and pressurised cabin prevents entry of dust from outside.

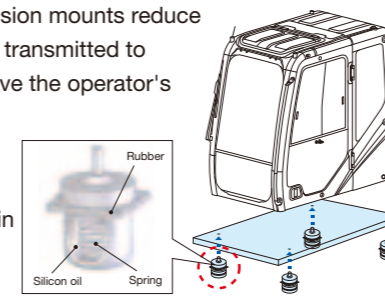

New OPG Level 2 Head Guard

OPG Level 2 head guard is available as an option. The see-through grille has been redesigned for better protection and visibility.



Easy Access to the Upper Structure



New larger front-right step

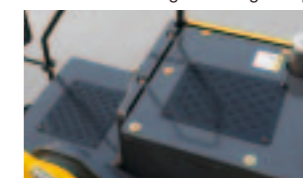

Non-slip plate

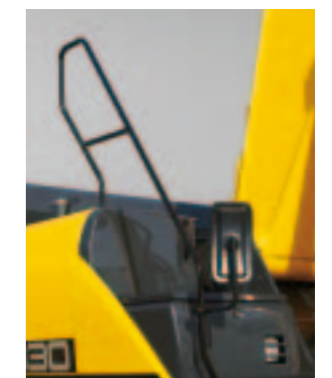

ISO-compliant large handrail

Cab Front Guard (option)

Optional cab front guard improves operator's safety from flying objects.



**Performance Refined.
Evolution Defined.**

Safety and Operator Comfort

The spacious cab on suspension mounts and reclining suspension seat softens operator fatigue and provide a relaxed environment.

Stylish and Spacious Cab

Wide cab space and floor space ensure more comfortable operation. In addition to the tilting console that is adjustable in four steps vertically, the increased sliding distance ensures optimum working conditions. Moreover, in cab noise level has been reduced by 2dB (as compared with SH350HD-5).

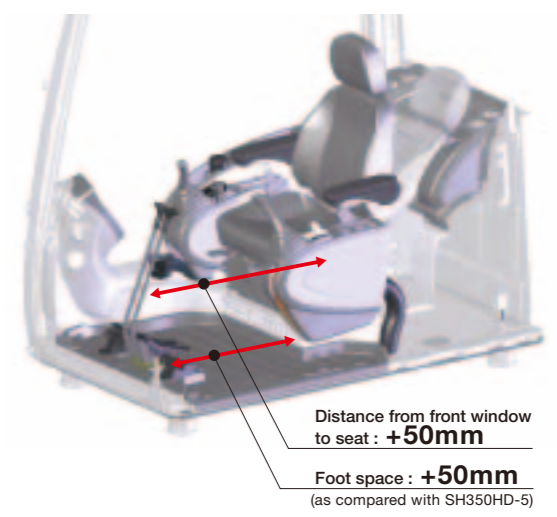

Super-comfortable Reclining Seat

The seat reclining system allows the operator to lay the seat flat and to rest on site without having to remove the headrest. The suspension seat eliminates vibration and fatigue. Air suspension is also available as option.

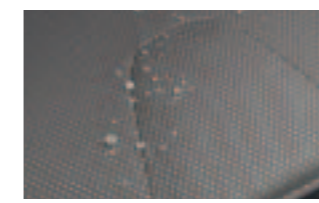

The highly water repellant seat covering is tough on dirt and water.



Air suspension (option)

Auxiliary Operation Pedal

The auxiliary operation pedal is lighter to depress and the pedal angle is adjustable.



Comfortable Equipment



Luggage space



Hot & cool box



Magazine rack

Automatic Air Conditioner

Fully automatic climate control is available through the eight vents, with an 8% stronger A/C unit, and a 24% improvement in airflow. (as compared with SH350HD-5)



Radio and Speaker with USB Port and MP3 Jack

In addition to the AM/FM radio and dual speaker system with improved sound quality, auxiliary audio port is provided standard for devices such as MP3 players.



Lever Switches

One-touch idle, horn, radio mute, or one-touch wiper buttons are installed on the operation levers in consideration of improved operability while working.



Radio mute switch (left lever)



One-touch wiper switch (right lever)



Safety and Operator Comfort

To support the operator in the field, the DASH 6 incorporates a 7" wide full colour LCD monitor with numerous functions and universally designed switch panel. The cabin with enhanced operator comfort ensures a safe working environment.

Large High-Definition LCD Monitor

A new large high-definition full colour LCD monitor has been introduced with better visibility and a switch panel which is easy to operate. Added functionality such as ECO gauge showing parameter of energy saving, display of operation status and warning messages, provides accurate information which improves work efficiency and safety.

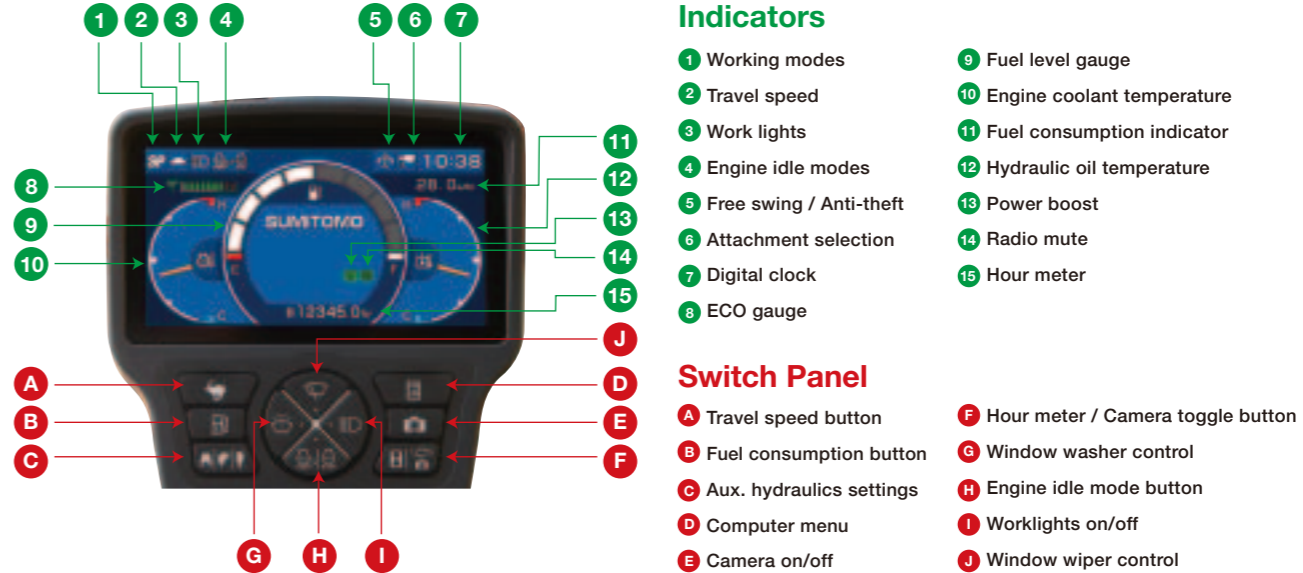

Rearview Camera (option)

With the rearview camera, the operator can view the image on the large LCD monitor. A side camera is available as option and up to two different images can be displayed on the monitor.



Rearview Mirror

The rearview mirrors reduce blind spots during operation. ISO compliant mirrors also available as option.



Specifications

SH330(LC)/350HD(LHD)-6 Technical Data

The electronic-controlled engine of SPACE 5+ and SIH:S+ (SUMITOMO Interigent Hydraulic System) includes: three working modes (SP, H and A), one-touch/automatic idling system and automatic power-boost.

Engine

SH330(LC)-6/SH350HD(LHD)-6	
Model	ISUZU GH-6HK1X
Type	Water-cooled, 4-cycle diesel, 6-cylinder in line, high pressure common rail system (electric control), Turbocharger with air cooled intercooler.
Rated output	200.0 kW · 271.9 PS /2,000 min ⁻¹
Maximum torque	983 N·m at 1,500min ⁻¹
Piston displacement	7.79 ltr
Bore and stroke	115 mm x 125 mm
Starting system	24 V electric motor starting
Alternator	24 V, 50 A
Fuel tank	580 ltr
Air filter	Double element

Hydraulic pumps

Two variable displacement axial piston pumps supply power for boom/arm/bucket, swing, and travel. One gear pump for pilot controls.

SH330(LC)-6/SH350HD(LHD)-6	
Maximum oil flow	2 x 300 ltr/min
Pilot pump max.oil flow	30 ltr/min

Hydraulic motors

For travel: Two variable displacement axial piston motors

For swing: One fixed displacement axial piston motor

Working circuit pressure

Boom/arm/bucket34.3 MPa (350 kgf/cm²)

Boom/arm/bucket37.3 MPa (380 kgf/cm²) with auto power-up

Swing circuit30.4 MPa (310 kgf/cm²)

Travel circuit34.3 MPa (350 kgf/cm²)

Control valve

With boom/arm holding valve

One 4-spool valve for right track travel, bucket, boom and arm acceleration

One 5-spool valve for left track travel, auxiliary, swing, boom acceleration and arm

Oil filtration

Return filter 6 micron

Pilot filter line 8 micron

Suction filter 105 micron

Hydraulic cylinders

Cylinder	Q'ty	Bore x Rod Diameter x Stroke
Boom	2	145 mm x 100 mm x 1495 mm
Arm	1	170 mm x 120 mm x 1748 mm
Bucket	1	150 mm x 105 mm x 1210 mm

Double-acting, bolt-up-type cylinder tube-end; hardened steel bushings are installed in the cylinder tube and rods ends.

Cabin & controls

The cabin is mounted on four fluid mountings. Features include safety glass front, rear and side windows, adjustable upholstered suspension seat with headrest and armrest, cigarette lighter, pop-up skylight window, and intermittent wiper with washer.

The front window slides upward for storage, and the lower front window is removable. Control levers are located in four positions with tilting control consoles. Built-in type full-colour monitor display. Membrane switch on monitor display.

Swing

Planetary reduction is powered by an axial piston motor. The internal ring gear with has a grease cavity for pinion. The swing bearing is a single-row shear type ball bearing. Dual stage relief valves are used for smooth swing deceleration and stops. A mechanical disc swing brake is included.

SH330(LC)-6/SH350HD(LHD)-6	
Swing speed	0~10.0 rpm
Tail swing radius	3,550 mm
Swing torque	112 kN·m (11,420 kgf·m)

Undercarriage

An X-style carbody is integrally welded for strength and durability. The grease cylinder track adjusters have shock absorbing springs. The undercarriage has lubricated rollers and idlers.

Type of shoe: sealed link shoe

Upper rollers -

Heat treated, mounted on steel bushings with leaded bronze casting, sealed for lifetime lubrication.

Lower rollers -

Heat treated, mounted on steel bushings with leaded bronze casting, sealed for lifetime lubrication.

Track adjustment -

Idler axles adjusted with grease cylinder integral with each side frame; adjustment yoke mechanism fitted with heavy duty recoil spring.

Number of rollers and shoes on each side

SH330-6/SH350HD-6	
Upper rollers	2
Lower rollers	7
Track shoes	45

SH330LC-6/SH350LHD-6	
Upper rollers	2
Lower rollers	8
Track shoes	48

Travel system

Two-speed independent hydrostatic system with compact axial motors for increased performance. Hydraulic motor powered output shaft coupled to a planetary reduction unit and track sprocket. All hydraulic components mounted within the width of side frame.

Travel speed can be selected by the switch panel on the monitor display.

Hydraulically released disc parking brake is built into each motor.

SH330(LC)-6/SH350HD(LHD)-6		
Travel speed	High	5.4 km/h
	Low	3.4 km/h
Drawbar pull		264/263 kN

Lubricant & coolant capacity

SH330(LC)-6/SH350HD(LHD)-6	
Hydraulic system	350 ltr
Hydraulic oil tank	175 ltr
Fuel tank	580 ltr
Cooling system	33 ltr
Final drive case (per side)	11 ltr
Swing drive case	5 ltr
Engine crank case (with remote oil filter)	41 ltr

Auxiliary hydraulic system

SH330(LC)-6			
Auxiliary piping type (option)	For Breaker	For Double (breaker & crusher) acting	For D/A + Second option line STD
Boom	STD	HD	HD
Arm type	STD	STD with Reinforcement plate	STD with Reinforcement plate
Bucket linkage type	HD	HD	HD
Auxiliary hydraulic pump flow	285 ltr/min	570 ltr/min	570 ltr/min+63 ltr/min

SH350HD(LHD)-6			
Auxiliary piping type (option)	For Breaker	For Double (breaker & crusher) acting	For D/A + Second option line STD
Arm type	HD	HD	HD
Bucket linkage type	HD	HD	HD
Auxiliary hydraulic pump flow	285 ltr/min	570 ltr/min	570 ltr/min+63 ltr/min

Bucket

Model	SH330(LC)-6				SH350HD(LHD)-6				
	Bucket capacity (ISO/SAE/PCSA heaped)	1.4 m ³	1.6 m ³	1.8 m ³	1.4HD m ³	1.6HD m ³	1.6HD ROCK m ³	1.8HD m ³	1.8HD ROCK m ³
Bucket capacity (CECE heaped)	1.21 m ³	1.36 m ³	1.53 m ³	1.21 m ³	1.36 m ³	1.39 m ³	1.55 m ³	1.55 m ³	
Bucket type	STD	STD	STD	HD	HD	HD ROCK	HD	HD ROCK	
Number of teeth	5	5	5	5	5	5	5	5	
Width	With side cutter	1 435 mm	1 575 mm	1 733 mm	1 424 mm	1 564 mm	—	1 722 mm	—
	Without side cutter	1 302 mm	1 442 mm	1 600 mm	1 310 mm	1 450 mm	1 325 mm	1 608 mm	1 465 mm
Weight		1 154 kg	1 224 kg	1 320 kg	1 514 kg	1 589 kg	1 668 kg	1 693 kg	1 766 kg
Combination	2.63 m arm	○	●	○	○	○	○	●	○
	3.25 m arm	●	○	N/A	○	●	○	○	○

○ Suitable for materials with density up to 2,000 kg/m³ or less

○ Suitable for materials with density up to 1,600 kg/m³

● Standard bucket (Suitable for materials with density up to 1,800 kg/m³ or less)

Weight & Ground Pressure

SH330(LC)-6			
Model			
Shoe type	Shoe width	Operating weight	Ground pressure
Triple grouser shoe	600 mm	34 100 kg (34 700 kg)	69 kPa (65 kPa)
	800 mm	34 900 kg (35 600 kg)	53 kPa (50 kPa)

SH350HD(LHD)-6			
Model			
Shoe type	Shoe width	Operating weight	Ground pressure
Triple grouser shoe	600 mm	36 200 kg (36 700 kg)	73 kPa (69 kPa)
	800 mm	36 900 kg (37 500 kg)	56 kPa (53 kPa)

Digging Force

SH330(LC)-6/SH350HD(LHD)-6			
Model			
Arm length	2.63 m		3.25 m
Bucket digging force	ISO 6015	232 kN <252 kN>	
<with auto power up>	SAE: PCSA	203 kN <221 kN>	
Arm digging force	ISO 6015	196 kN <213 kN>	165 kN <179 kN>
<with auto power up>	SAE: PCSA	186 kN <202 kN>	158 kN <172 kN>

Lifting Capacity

Notes: 1. Ratings are based on ISO 10567

- Lifting capacity does not exceed 75% of tipping load with the machine on firm, level ground or 87% full hydraulic capacity.
- The load point is a hook (not standard equipment) located on the back of the bucket.
- *Indicates load limited by hydraulic capacity.
- 0 m = Ground.

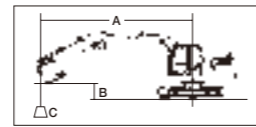

A: Radius of load
B: Bucket hook height
C: Lifting capacity



Unit: kg

SH330-6

SHOE : 600 (mm)G
BUCKET : SAE/PCSA 1.40 (m³)
ARM LENGTH : 4.04 (m)
MAXIMUM REACH : 11.90 (m)
BOOM : 6.45 (m)
COUNTERWEIGHT : 6 400 kg

Bucket Hook Height	Radius of Load													
	Max. Radius	11 m	10 m	9 m	8 m	7 m	6 m	5 m	4 m	3 m	2 m	1 m	0 m	Min. Radius
9 m	2 940*	2 940*												3 340*
8 m	2 810*	2 810*												4 700*
7 m	2 740*	2 740*												5 870*
6 m	2 710*	2 710*												6 310*
5 m	2 730*	2 730*												6 830*
4 m	2 770*	2 770*												6 090*
3 m	2 850*	2 850*												11 710*
2 m	2 960*	2 960*												6 740*
1 m	3 120*	3 120*												4 730*
0 m	3 340*	3 340*												4 490*
-1 m	3 620*	3 620*												5 430*
-2 m	4 000*	4 000*												8 400*
-3 m	4 520*	4 520*												10 250*
-4 m	5 220*	5 220*												11 650*
-5 m	6 090*	6 090*												14 880*
-6 m	6 710*	6 710*												20 510*
-7 m	6 420*	6 420*												14 650*

SH330-6

SHOE : 600 (mm)G
BUCKET : SAE/PCSA 1.40 (m³)
ARM LENGTH : 3.25 (m)
MAXIMUM REACH : 11.20 (m)
BOOM : 6.45 (m)
COUNTERWEIGHT : 6 400 kg

Bucket Hook Height	Radius of Load											
	Max. Radius	10 m	9 m	8 m	7 m	6 m	5 m	4 m	3 m	2 m	1 m	Min. Radius
9 m	3 840*											4 080*
8 m	3 660*											5 700*
7 m	3 570*											7 170*
6 m	3 530*											7 490*
5 m	3 550*											6 750*
4 m	3 610*											9 530*
3 m	3 700*											10 450*
2 m	3 840*											7 000*
1 m	4 040*											5 750*
0 m	4 310*											5 730*
-1 m	4 690*											6 070*
-2 m	5 050*											8 880*
-3 m	5 570*											11 700*
-4 m	6 380*											15 240*
-5 m	7 270*											20 820*
-6 m	7 050*											16 830*

SH330-6

SHOE : 600 (mm)G
BUCKET : SAE/PCSA 1.60 (m³)
ARM LENGTH : 2.63 (m)
MAXIMUM REACH : 10.70 (m)
BOOM : 6.45 (m)
COUNTERWEIGHT : 6 400 kg

Bucket Hook Height	Radius of Load										
	Max. Radius	10 m	9 m	8 m	7 m	6 m	5 m	4 m	3 m	2 m	Min. Radius
8 m	5 220*										5 830*
7 m	5 060*										7 950*
6 m	4 980*										8 440*
5 m	4 980*										10 180*
4 m	4 810*										13 020*
3 m	4 660*										11 000*
2 m	4 610*										10 870*
1 m	4 650*										9 420*
0 m	4 800*										8 630*
-1 m	5 070*										8 560*
-2 m	5 500*										9 130*
-3 m	6 170*										13 390*
-4 m	7 240*										18 960*
-5 m	6 890*										19 340*

Notes: 1. Ratings are based on ISO 10567

- Lifting capacity does not exceed 75% of tipping load with the machine on firm, level ground or 87% full hydraulic capacity.
- The load point is a hook (not standard equipment) located on the back of the bucket.
- *Indicates load limited by hydraulic capacity.
- 0 m = Ground.

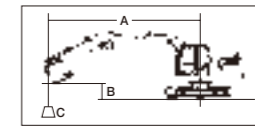

A: Radius of load
B: Bucket hook height
C: Lifting capacity



Unit: kg

SH330LC-6

SHOE : 600 (mm)G
BUCKET : SAE/PCSA 1.40 (m³)
ARM LENGTH : 4.04 (m)
MAXIMUM REACH : 11.90 (m)
BOOM : 6.45 (m)
COUNTERWEIGHT : 6 400 kg

Bucket Hook Height	Radius of Load													
	Max. Radius	11 m	10 m	9 m	8 m	7 m	6 m	5 m	4 m	3 m	2 m	1 m	0 m	Min. Radius
9 m	2 940*													3 340*
8 m	2 810*													4 700*
7 m	2 740*													5 870*
6 m	2 710*													6 310*
5 m	2 730*													6 830*
4 m	2 770*													6 090*
3 m	2 850*													11 710*
2 m	2 960*													6 740*
1 m	3 120*													4 730*
0 m	3 340*													4 490*
-1 m	3 620*													5 430*
-2 m	4 000*													8 400*
-3 m	4 520*													10 250*
-4 m	5 220*													11 650*
-5 m	6 540*													14 880*
-6 m	6 710*													20 510*
-7 m	6 420*													14 650*

SH330LC-6

SHOE : 600 (mm)G
BUCKET : SAE/PCSA 1.40 (m³)
ARM LENGTH : 3.25 (m)
MAXIMUM REACH : 11.20 (m)
BOOM : 6.45 (m)
COUNTERWEIGHT : 6 400 kg

Bucket Hook Height	Radius of Load											
	Max. Radius	10 m	9 m	8 m	7 m	6 m	5 m	4 m	3 m	2 m	1 m	Min. Radius
9 m	3 840*											4 080*
8 m	3 660*											5 700*
7 m	3 570*											7 170*
6 m	3 530*											7 490*
5 m	3 550*											6 750*
4 m	3 610*											9 530*
3 m	3 700*											10 450*
2 m	3 840*											7 000*
1 m	4 040*											5 750*
0 m	4 310*											5 730*
-1 m	4 690*											6 070*
-2 m	5 210*											8 880*
-3 m	5 990*											11 700*
-4 m	7 170*											15 240*
-5 m	7 270*											20 820*
-6 m	7 050*											16 830*

SH330LC-6

SHOE : 600 (mm)G
BUCKET : SAE/PCSA 1.60 (m³)
ARM LENGTH : 2.63 (m)
MAXIMUM REACH : 10.70 (m)
BOOM : 6.45 (m)
COUNTERWEIGHT : 6 400 kg

Bucket Hook Height	Radius of Load										
	Max. Radius	10 m	9 m	8 m	7 m	6 m	5 m	4 m	3 m	2 m	Min. Radius
8 m	5 220*										5 830*
7 m	5 060*										7 950*
6 m	4 980*										8 440*
5 m	4 980*										10 180*
4 m	5 030*										13 020*
3 m	5 130*										11 000*
2 m	5 310*										10 870*
1 m	5 400*										9 420*
0 m	5 570*										8 630*
-1 m	5 880*										8 560*
-2 m	6 370*										9 130*
-3 m	7 140*										13 390*
-4 m	7 270*										18 960*
-5 m	6 890*										19 340*

Lifting Capacity

Notes: 1. Ratings are based on ISO 10567

- Lifting capacity does not exceed 75% of tipping load with the machine on firm, level ground or 87% full hydraulic capacity.
- The load point is a hook (not standard equipment) located on the back of the bucket.
- *Indicates load limited by hydraulic capacity.
- 0 m = Ground.

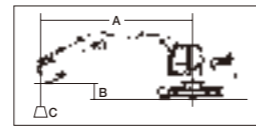

A: Radius of load
B: Bucket hook height
C: Lifting capacity



Unit: kg

SH350HD-6

SHOE : 600 (mm)G
BUCKET : SAE/PCSA 1.40 (m³)
ARM LENGTH : 3.25 (m)
MAXIMUM REACH : 11.20 (m)
BOOM : 6.45 (m)
COUNTERWEIGHT : 7 400 kg

Bucket Hook Height	Max. Radius		10 m		9 m		8 m		7 m		6 m		5 m		4 m		3 m		2 m		1 m		Min. Radius					
	(kg)	(m)	(kg)	(m)	(kg)	(m)	(kg)	(m)	(kg)	(m)	(kg)	(m)	(kg)	(m)	(kg)	(m)	(kg)	(m)	(kg)	(m)	(kg)	(m)	(kg)	(m)				
9 m	3 490*	8.23	3 490*	8.23			4 460*	4 460*																3 740*	7.68	3 740*	7.68	
8 m	3 310*	9.04	3 310*	9.04			3 540*	3 540*	5 630*	5 630*														5 370*	7.34	5 370*	7.34	
7 m	3 210*	9.65	3 210*	9.65			5 640*	4 840	6 310*	6 140														6 720*	7.31	6 720*	7.31	
6 m	3 170*	10.11	3 170*	10.11	3 840*	3 750*	6 200*	4 770	6 800*	6 050														7 030*	7.03	7 030*	7.03	
5 m	3 180*	10.43	3 180*	10.43	5 310	3 710	6 510*	4 660	7 090*	5 880	7 670*	7 440	7 630*	7 630*										6 480*	5.90	6 480*	5.90	
4 m	3 240*	10.64	3 130	10.64	5 240	3 630	6 420	4 520	7 610*	5 670	8 510*	7 220	9 730*	9 300*	11 560*	11 560*	14 320*	14 320*						9 170*	2.22	9 170*	2.22	
3 m	3 330*	10.74	3 000	10.74	5 140	3 530	6 260	4 370	7 730	5 450	9 290*	6 900	10 880*	8 960	13 370*	12 070	16 570*	16 570*	17 490*	17 490*				10 090*	2.77	10 090*	2.77	
2 m	3 480*	10.73	2 950	10.73	5 040	3 440	6 100	4 230	7 500	5 240	9 420*	6 610	11 900*	8 510	14 860*	11 370	18 410*	16 170	7 590*	7 590*				6 650*	2.93	6 650*	2.93	
1 m	3 680*	10.63	2 960	10.63	4 950	3 350	5 960	4 100	7 300	5 050	9 130	6 340	11 790	8 120	15 760	10 790	19 600*	15 280	7 660*	7 660*				5 410*	2.72	5 410*	2.72	
0 m	3 950*	10.43	3 040	10.43	4 880	3 290	5 850	3 990	7 130	4 900	8 900	6 120	11 460	7 830	15 560	10 400	18 390*	14 770	10 180*	10 180*				5 390*	2.02	5 390*	2.02	
-1 m	4 340*	10.12	3 200	10.12	4 860	3 270	5 780	3 920	7 020	4 790	8 730	5 970	11 250	7 640	15 330	10 200	19 760*	14 650	12 600*	12 600*	9 490*	9 490*	7 150*	7 150*	5 710*	0.92	5 710*	0.92
-2 m	4 860*	9.69	3 470	9.69			5 780	3 930	6 990	4 770	8 680	5 930	11 200	7 600	15 320	10 210	20 280*	14 890	15 380*	15 380*	12 520*	12 520*	11 230*	11 230*	8 520*	0.69	8 520*	0.69
-3 m	5 640*	9.13	3 680	9.13			5 870	4 010	7 050	4 830	8 730	5 980	11 250	7 660	15 270*	10 300	19 330*	15 040	18 790*	18 790*	15 070*	15 070*	13 800*	13 800*	11 320*	0.71	11 320*	0.71
-4 m	6 560	8.43	4 500	8.43			7 160	5 020	8 840*	6 120	11 290	7 800	14 410*	10 470	17 840*	15 280	22 650*	22 650*	18 460*	18 460*	15 180*	15 180*	14 860*	0.99	14 860*	0.99		
-5 m	6 710*	7.54	5 520	7.54					8 290*	6 340	10 390*	8 060	12 730*	10 700	15 640*	15 190	19 630*	19 630*	22 720*	22 720*				20 420*	1.59	20 420*	1.59	
-6 m	6 480*	6.39	6 480*	6.39							7 720*	7 720*	10 000*	10 000*	12 370*	12 370*	15 260*	15 260*						16 000*	2.79	16 000*	2.79	

SH350HD-6

SHOE : 600 (mm)G
BUCKET : SAE/PCSA 1.60 (m³)
ARM LENGTH : 2.63 (m)
MAXIMUM REACH : 10.70 (m)
BOOM : 6.45 (m)
COUNTERWEIGHT : 7 400 kg

Bucket Hook Height	Max. Radius		10 m		9 m		8 m		7 m		6 m		5 m		4 m		3 m		2 m		Min. Radius						
	(kg)	(m)	(kg)	(m)	(kg)	(m)	(kg)	(m)	(kg)	(m)	(kg)	(m)	(kg)	(m)	(kg)	(m)	(kg)	(m)	(kg)	(m)	(kg)	(m)					
8 m	4 930*	8.42	4 930*	8.42			6 700*	6 030	6 460*	6 460*														5 730*	6.72	5 730*	6.72
7 m	4 760*	9.08	4 550	9.08			5 430*	4 660	7 030*	6 000	7 540*	7 510												7 600*	6.69	7 600*	6.69
6 m	4 680*	9.57	4 010	9.57			6 530	4 630	7 470*	5 890	7 770*	7 480												8 080*	6.35	8 080*	6.35
5 m	4 680*	9.91	3 650	9.91			6 430	4 540	7 670*	5 730	8 340*	7 310	9 360*	9 340	10 870*	10 870*								9 980*	4.78	9 980*	4.78
4 m	4 720*	10.13	3 420	10.13	5 140	3 540	6 310	4 420	7 800	5 540	9 060*	7 030	10 470*	9 150	12 430*	12 150	14 780*	14 780*						12 650*	3.19	12 650*	3.19
3 m	4 820*	10.24	3 280	10.24	5 070	3 470	6 170	4 290	7 600	5 340	9 490	6 740	11 540*	11 680	13 750*	11 680	17 320*	16 590						10 710*	3.62	10 710*	3.62
2 m	4 770	10.23	3 230	10.23	4 990	3 390	6 030	4 160	7 400	5 150	9 270	6 470	11 920*	8 300	15 010*	11 020	16 500*	15 340*						10 650*	3.74	10 650*	3.74
1 m	4 820	10.12	3 250	10.12	4 930	3 340	5 920	4 050	7 220	4 990	9 020	6 240	11 610	7 960	15 720	10 540	14 420*	14 420*						9 150*	3.59	9 150*	3.59
0 m	4 970	9.91	3 360	9.91			5 830	3 980	7 090	4 860	8 820	6 060	11 350	7 730	15 400	10 260	15 870*	14 390*						8 360*	3.10	8 360*	3.10
-1 m	5 260	9.58	3 370	9.58			5 800	3 950	7 010	4 790	8 710	5 950	11 220	7 620	15 340	10 220	18 850*	14 500	12 420*	12 420*				8 270*	2.08	8 270*	2.08
-2 m	5 720	9.13	3 900	9.13			5 880	4 020	7 040	4 820	8 270	5 970	11 240	7 650	15 330	10 280	19 590*	15 080	15 900*	15 900*	13 930*	13 930*		8 510*	1.31	8 510*	1.31
-3 m	6 440	8.54	4 420	8.54			7 180*	4 970	8 820	6 070	11 340	7 750	14 870*	10 420	18 300*	15 250	20 370*	20 370*	16 520*	16 520*	13 070*	13 070*		8 810*	1.31	8 810*	1.31
-4 m	6 840*	7.78	5 240	7.78					8 820	6 320	11 090*	7 950	13 470*	10 640	16 420*	15 280	20 300*	20 300*	20 950*	20 950*	18 640*	18 640*		8 640*	1.67	8 640*	1.67
-5 m	6 450*	6.81	6 450*	6.81							9 000*	8 050	11 240*	10 660	13 680*	13 680*	16 630*	16 630*						18 690*	2.44	18 690*	2.44

SH350LHD-6

SHOE : 600 (mm)G
BUCKET : SAE/PCSA 1.40 (m³)
ARM LENGTH : 3.25 (m)
MAXIMUM REACH : 11.20 (m)
BOOM : 6.45 (m)
COUNTERWEIGHT : 7 400 kg

Bucket Hook Height	Max. Radius		10 m		9 m		8 m		7 m		6 m		5 m		4 m		3 m		2 m		1 m		Min. Radius				
	(kg)	(m)	(kg)	(m)	(kg)	(m)	(kg)	(m)	(kg)	(m)	(kg)	(m)	(kg)	(m)	(kg)	(m)	(kg)	(m)	(kg)	(m)	(kg)	(m)	(kg)	(m)			
9 m	3 490*	8.23	3 490*	8.23			4 460*	4 460*																3 740*	7.68	3 740*	7.68
8 m	3 310*	9.04	3 310*	9.04			3 540*	3 540*	5 630*	5 630*														5 370*	7.34	5 370*	7.34
7 m	3 210*	9.65	3 210*	9.65			5 640*	4 910	6 310*	6 200*														6 720*	7.31	6 720*	7.31
6 m	3 170*	10.11	3 170*	10.11	3 840*	3 810	6 200*	4 850	6 800*	6 140														7 030*	7.03	7 030*	7.03
5 m	3 180*	10.43	3 180*	10.43	5 400*	3 770	6 560*	4 730	7 090*	5 960	7 670*	7 510	7 630*	7 630*										6 480*	5.90	6 480*	5.90
4 m	3 240*	10.64	3 190	10.64	6 020	3 690	6 990*	4 600	7 610*	5 750	8 510*	7 310	9 730*	9 390*	11 560*	11 560*	14 320*	14 320*						9 170*	2.22	9 170*	2.22
3 m	3 330*	10.74	3 060	10.74	5 920	3 600	7 160*	4 450	8 190*	5 540	9 290*	7 000	10 880*	9 090	13 370*	12 190	16 570*	16 570*	17 490*	17 490*				10 090*	2.77	10 090*	2.77
2 m	3 480*	10.73	3 010	10.73	5 820	3 500	7 020	4 300	8 540	5 330	9 990*	6 710	11 900*	8 630	14 860*	11 530	18 410*	16 380	7 590*	7 590*				6 650*	2.93	6 650*	2.93
1 m	3 680*	10.63	3 020	10.63	5 730	3 420	6 880	4 170																			

Working Range

		SH330(LC)-6	
Arm length		2.63 m	3.25 m
Boom length		6.45 m	
A Max digging radius		10 670 mm	11 170 mm
B Max digging depth		6 730 mm	7 340 mm
C Max digging height		10 320 mm	10 370 mm
D Max dumping height		7 140 mm	7 230 mm
E Max vertical wall cut depth		5 970 mm	6 350 mm
F Min front swing radius		4 630 mm	4 500 mm
G Rear end swing radius		3 550 mm	

		SH350HD(LHD)-6	
Arm length		2.63 m	3.25 m
Boom length		6.45 m	
A Max digging radius		10 670 mm	11 170 mm
B Max digging depth		6 730 mm	7 340 mm
C Max digging height		10 320 mm	10 370 mm
D Max dumping height		7 140 mm	7 230 mm
E Max vertical wall cut depth		5 970 mm	6 350 mm
F Min front swing radius		4 630 mm	4 500 mm
G Rear end swing radius		3 550 mm	

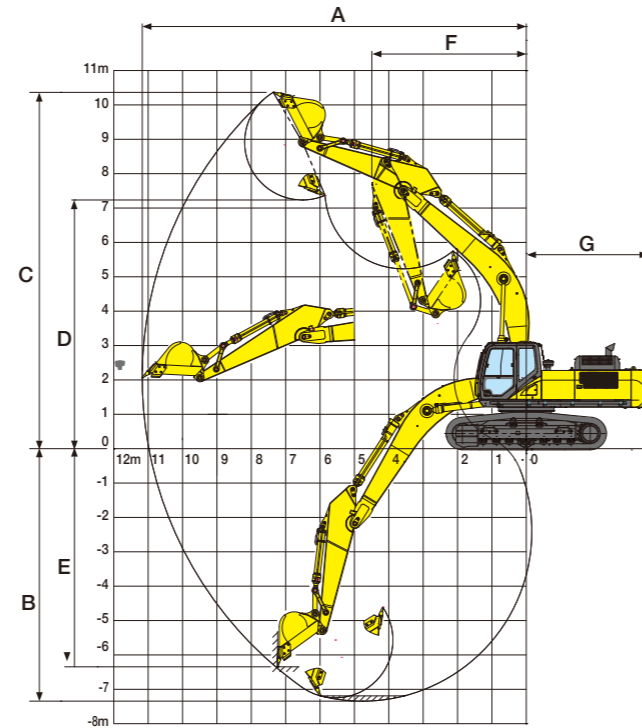

Principle Specifications

	SH330-6	SH330LC-6	SH350HD-6	SH350LHD-6
	STD Specifications	STD Specifications	STD Specifications	STD Specifications
Base				
Boom length		6.45 m		6.45 m (HD type)
Arm length		3.25 m		3.25 m (HD type)
Bucket capacity (ISO heaped)		1.4 m ³		1.6 m ³ (HD type)
Std. operating weight	34 100 kg	34 700 kg	36 700 kg	37 500 kg
Engine		ISUZU GH-6HK1X		
Rated output		200.0 kW/2 000 min ⁻¹		
Displacement		7.79 ltr		
Hydraulic System		2 variable displacement axial piston pumps with regulating system		
Main pump				
Max pressure		34.3 MPa		
/with auto power boost		37.3 MPa		
Travel motor		Variable displacement axial piston motor		
Parking brake type		Mechanical disc brake		
Swing motor		Fixed displacement axial piston motor		
Travel speed		5.4/3.4 km/h		
Drawbar pull		264 kN		263 kN
Gradeability			70% (<35°)	
Ground pressure	69 kPa	65 kPa	73 kPa	69 kPa
Swing speed			10.0 min ⁻¹	
Bucket digging force			232 kN	
/with power boost			252 kN	
Arm digging force			196 kN	
/with power boost			213 kN	
Others			580 ltr	
Fuel tank			175 ltr	
Hydraulic fluid tank				

Standard Equipment

[Hydraulic system]

- SIH:S+ hydraulic system
- Operation mode (SP, H and A mode)
- Automatic 2-speed travel
- Automatic power boost
- Arm/boom/bucket reactivation circuit
- Automatic swing parking system
- High-performance return filter

[Cabin/interior equipment]

- Strengthened cabin
- Top guard OPG level1 (in cab structure)
- Shock-less cab suspension by 4-point fluid mounts
- Built-in type full-colour monitor display
- Tilting console
- Open air introducing pressurised full-automatic air conditioner
- Defroster
- Hot & cool box
- Water-resistant seat
- Seat suspension
- Windscreen wiper (with intermittent operation function)
- Cup holder
- AM/FM radio (with muting function) with AUX port & USB port
- Radio mute / Windscreen wiper one-touch control on joystick
- Clock
- Magazine rack
- Accessory case
- Floor mat
- Armrest & headrest
- Ashtray & cigarette lighter
- Cab light (Auto-OFF function)
- Coat hook

[Safety equipment]

- Rearview mirror (left/right)
- Emergency escape tool
- Retracting seat belt
- Gate lock lever
- Travel alarm (with on and off switch)
- Anti-theft alarm system
- Engine room firewall
- Fan guard
- Engine emergency stop switch
- Engine neutral start

[Others]

- Auto/one-touch idling
- Auto idle shutdown system
- EMS
- Long-life hydraulic oil
- Two lights (main unit and left of boom)
- Fuel filter (with water separator)
- Fuel prefilter (with water separator)
- Double-element air cleaner
- Grease-enclosed track link
- Large tool box
- A set of tools
- Precleaner (cup type)
- Grouped greasing for TTB

Accessories (option)

■ Cabin-top lights



■ Front guard (OPG level 1 or 2)



■ Front net guard (full/lower)



■ Head guard (OPG level 2)



■ Side camera



■ Rear view camera



■ Full track guard

■ Refuel pump

■ Increased counterweight

■ ISO compliant mirror

■ Sun visor

■ Rain deflector

■ Polycarbonate roof top window with sunshade

■ ISO compliant guardrail

■ Hose burst check valve (HBCV) for boom/arm cylinders

■ Air suspension (KAB seat)

■ ROPS Cabin

■ 12V power (DC-DC converter)

■ Precleaner (cyclone type)

Dimensions

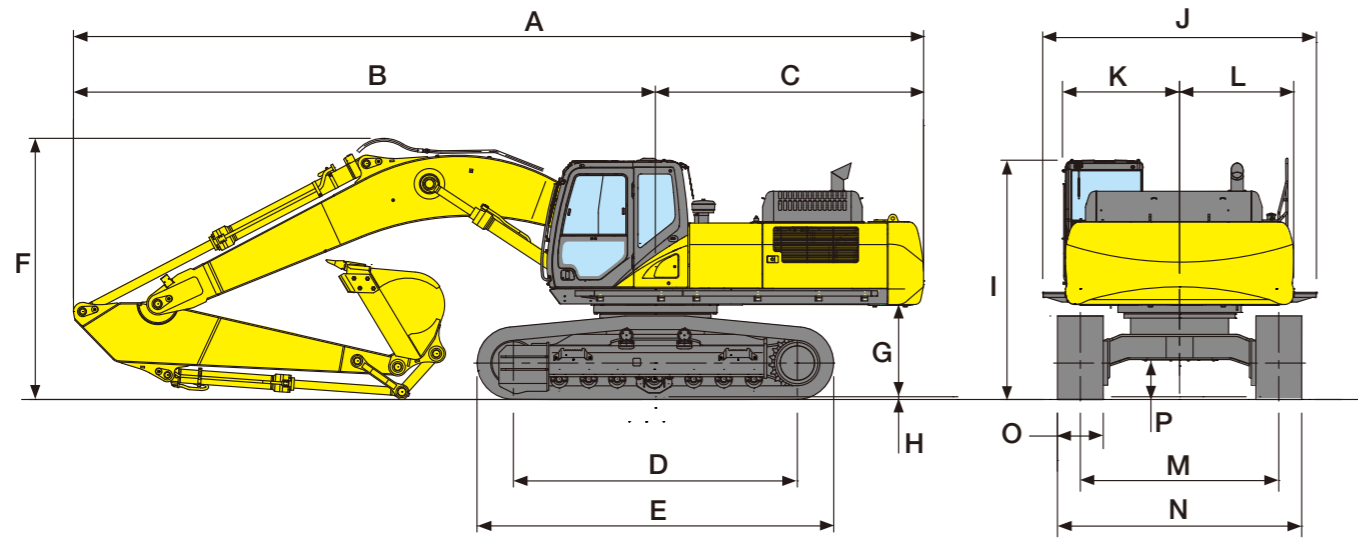

Model	SH330-6		SH330LC-6	
Arm length	2.63 m	3.25 m	2.63 m	3.25 m
A Overall length	11 230 mm	11 140 mm	11 230 mm	11 140 mm
B Length from centre of machine (to arm top)	7 700 mm	7 620 mm	7 700 mm	7 620 mm
C Length from centre of machine (to rear end)	3 520 mm			
D Centre to centre of wheels	3 720 mm		4 040 mm	
E Overall track length	4 650 mm		4 980 mm	
F Overall height	3 640 mm	3 420 mm	3 640 mm	3 420 mm
G Clearance height under upper structure	1 200 mm			
H Shoe lug height	36 mm			
I Cab height	3 130 mm			
J Upper structure overall width	3 030 mm			
K Width from centre of machine (left side)	1 540 mm			
L Width from centre of machine (right side)	1 490 mm			
M Track gauge	2 600 mm			
N Overall width	3 400 mm			
O Std. shoe width	800 mm			
P Minimum ground clearance	480 mm			

Model	SH350HD-6		SH350LHD-6	
Arm length	2.63 m	3.25 m	2.63 m	3.25 m
A Overall length	11 230 mm	11 140 mm	11 230 mm	11 140 mm
B Length from centre of machine (to arm top)	7 700 mm	7 620 mm	7 700 mm	7 620 mm
C Upper structure rear end radius	3 520 mm			
D Centre to centre of wheels	3 720 mm		4 040 mm	
E Overall track length	4 650 mm		4 980 mm	
F Overall height	3 640 mm	3 420 mm	3 640 mm	3 420 mm
G Clearance height under upper structure	1 200 mm			
H Shoe lug height	36 mm			
I Cab height	3 130 mm			
J Upper structure overall width	3 120 mm			
K Width from centre of machine (left side)	1 560 mm			
L Width from centre of machine (right side)	1 560 mm			
M Track gauge	2 600 mm			
N Overall width	3 400 mm			
O Std. shoe width	800 mm			
P Minimum ground clearance	480 mm			

● Boom

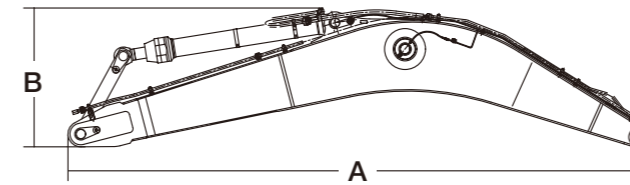

● Arm

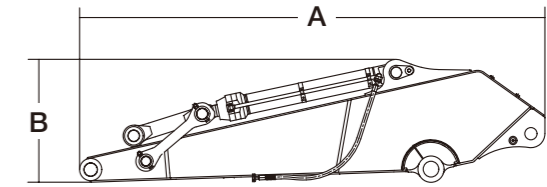

● Bucket

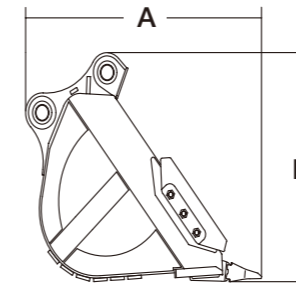

● Counterweight

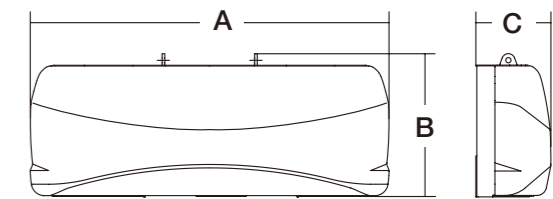

Boom

Model	SH330(LC)-6	SH350HD(LHD)-6
A	6.71 m	
B	1 710 mm	
Width	860 mm	
Weight	3 970 kg	4 260 kg

Arm

Model	SH330(LC)-6/SH350HD(LHD)-6			
Type	HD Short (2.63 m)		HD Standard (3.25 m)	
A	3 770 mm		4 400 mm	
B	1 150 mm		1 090 mm	
Width	390 mm			
Weight	1 900 kg (SH330)/1 970 kg (SH350)		1 820 kg (SH330)/2 100 kg (SH350)	

Bucket

Model	SH330(LC)-6			SH350HD(LHD)-6				
Bucket capacity (ISO/SAE/PCSA heaped)	1.4 m ³	1.6 m ³	1.8 m ³	1.4HD m ³	1.6HD m ³	1.6HD ROCK m ³	1.8HD m ³	1.8HD ROCK m ³
A	1 740 mm			1 730 mm			1 720 mm	
B	1 380 mm			1 400 mm				
Width	With side cutter	1 435 mm	1 575 mm	1 733 mm	1 424 mm	1 564 mm	—	1 722 mm
	Without side cutter	1 302 mm	1 442 mm	1 600 mm	1 310 mm	1 450 mm	1 325 mm	1 608 mm
Weight		1 170 kg	1 240 kg	1 320 kg	1 510 kg	1 590 kg	1 668 kg	1 700 kg

Counterweight

Model	SH330(LC)-6		SH350HD(LHD)-6	
A	2 990 mm			
B	1 194 mm			
C	725 mm			
Weight	6 400 kg		7 400 (7 700) kg	